



GeKaMac®



Power Plus+ TIG 320 DC Pulse

Users Manual

Please Read and Understand This Manual
Before Operating The Welding Machine

www.gedikwelding.com

OPERATOR'S MANUAL

Power Plus+ TIG 320/400 DC Pulse INVERTER DC PULSE TIG WELDER

IMPORTANT: Read this Owner's Manual Completely before attempting to use this equipment. Save this manual and keep it handy for quick reference. Pay particular attention to the safety instructions we have provided for your protection. Contact your distributor if you do not fully understand this manual.

This machine is for internal use only.

It complies with the WEEE Directive.

This machine has been designed in accordance with the EN 60974-1 and EN 60974-10 standards.

The machine is safe when installation, operation, and maintenance are performed in accordance with the user manual and regulations. The operator and machine owner are responsible for adhering to safety rules.

Gedik Kaynak San. Ve Tic. A.Ş. assumes no responsibility for safety or CE compliance if any modifications are made to the machine or if safety rules are not followed.



This Class A equipment is not suitable for use in homes and similar residential areas where the power supply is provided by the low-voltage public electricity network.



This machine is not household waste and cannot be disposed of in the trash.

When the machine reaches the end of its service life or becomes obsolete, it must be disposed of in accordance with regulations.

COMPLIES WITH THE WEEE DIRECTIVE.

Eco Design Statement

This machine has been designed and manufactured in accordance with the requirements of the 2009/125/EC Eco Design Directive concerning the environmentally friendly design of energy-related products.

Accordingly, machines with an idle mode are as follows.

	Idle Mode
MMA	X
MIG	√
TIG	√
Plazma	√
SAW	Out of Scope

Efficiency measurements should be conducted only on the power unit. The water cooling system should be disabled. For more information on measurements and machine settings, Gedik Kaynak Sanayi ve Ticaret A.Ş. should be consulted.

**AT UYGUNLUK BEYANI****EU DECLARATION OF CONFORMITY**

Bu uygunluk beyanı yalnızca imalatçının sorumluluğu altında düzenlenir.

This declaration of conformity is issued under the sole responsibility of the manufacturer.

İstanbul, Turkey, 08.03.2024

İmalatçı / Manufacturer

GEDİK KAYNAK SANAYİ ve TİCARET A.Ş.

Ankara Cad. No.306 Seyhli Pendik İSTANBUL TÜRKİYE

Ürün / Product

ARC WELDING MACHINE

Marka-Model / Brand- Model

PoWerPlus TIG 320 DC PULSE

Yukarıda tanımlanan beyanın nesnesi ilgili uyumlaştırılmış AB mevzuatı ile uyumludur.

The object of the declaration described above, is in conformity with the relevant union harmonisation legislation.

Direktifler / Directives

2014/30/EU & 2014/35/EU & 2009/125/EC

Uyumlaştırılmış standartlar ve uygunluğun deklare edilmesiyle ilişkili diğer referanslar.

References to the relevant harmonised standards used and references to the other technical specifications in relation to which conformity is declared.

EN IEC 60974-1:2018-A1:2019
EN IEC 60974-10:2021

Bu ekipman, talimatlara uygun kurulduğunda, bakımı yapıldığında ve kullanıldığında belirtilen standartlara uygundur. Makine üzerinde bir değişiklik yapıldığında veya yanlış kullanımda deklarasyon geçersiz olur.

The equipment is in compliance with pertinent legislation when installed, utilized, and maintained in accordance with the enclosed instructions. This declaration will be invalid under any modification or improper use.

İmalatçı Adına imzalayan / Signed for and on behalf of:

Hatice Özel, Equipment Business Unit Director



CONTENT

§1 SAFETY	1
§2 SUMMARY.....	9
§2.1 Brief Introduction.....	9
§2.2 Parameters.....	11
§2.3 Duty cycle & Over heat	12
§2.4 Working Principle	12
§2.5 Volt-Ampere Characteristic	13
§3 Installation & Operation.....	14
§3.1 Layout for Front and Rear panel.....	14
§3.2 Layout for Control panel.....	15
§3.3 Installation & Operation for MMA welding.....	22
§3.3.1 Set up installation for MMA Welding.....	22
§3.3.2 Operation for MMA Welding.....	23
§3.3.3 MMA Welding.....	24
§3.3.4 MMA Welding Fundamentals	25
§3.4 Installation & Operation for TIG welding.....	28
§3.4.1 Set up installation for TIG Welding.....	28
§3.4.2 DC TIG Welding	29
§3.4.3 TIG Welding Fusion Technique.....	30
§3.4.4 Tungsten Electrodes.....	32
§3.4.5 Tungsten Preparation.....	34
§3.4.6 Gun switch control current.....	36
§3.4.7 Pedal switch control.....	37
§3.5 Operation Environment.....	39
§3.6 Operation Notices	39
§4 Maintenance & Troubleshooting.....	40
§4.1 Maintenance	40
§4.2 Troubleshooting.....	41
§4.3 Electrical principle drawing.....	44

§1 SAFETY

Notice: The instructions are for reference only. The manufacturer reserves the right to explain the differences between the description and the product due to product changes and upgrades!

The device is manufactured using state-of-the-art technology and according to recognised safety standards. If used incorrectly or misused, however, it can cause:

- Injury or death to the operator.
- Damage to the device and other material assets belonging to the operating company.
- Inefficient operation of the device.



General

All persons involved in commissioning, operating, maintaining and servicing the device must:

- Be suitably qualified.
- Have sufficient knowledge of welding.
- Read and follow these operating instructions carefully.

The operating instructions must always be at hand wherever the device is being used. In addition to the operating instructions, attention must also be paid to any generally applicable and local regulations regarding accident prevention and environmental protection.

Before switching on the device, rectify any faults that could compromise safety.

This is for your personal safety!

Environment

Products are limited to use under suitable conditions. In extreme cases, the use of products, such as high temperature, low temperature, thunderstorm weather, will shorten the life of the machine and even cause damage, please avoid the above situation.



Excessive ambient temperature will cause the machine heat dissipation is not smooth, so that the internal components of the machine heat seriously. Usually the maximum operating temperature is 104°F (40°C).



Low temperature may lead to performance degradation or damage of components inside the product, resulting in ice inside the water tank. Usually the lowest operating temperature is 14°F (-10°C). Please keep warm and add antifreeze in the water tank if necessary.



Too humid environment may lead to rust of shell and circuit components. In rainy weather, using products may lead to short circuit and other abnormalities. Please try to avoid using in the above environment. If the machine is wet, please dry in time.

Areas

Running parts and specific parts of risk will take damage for your body or others. The corresponding notices are as follows. It is quite a safe operation after taking several necessary protection measures.



Items being welded generate and hold high heat and can cause severe burns. Don't touch hot parts with bare hands. Allow a cooling period before working on the welding gun. Use insulated welding gloves and clothing to handle hot parts and prevent burns.



A high risk of injury exists when the welding wire emerges from the welding torch. Always keep the torch well away from the body.



Keep all equipment safety guards, covers and devices in position and in good repair. Keep hands, hair, clothing and tools away from V-gears, fans and all other moving parts when starting, operating or repairing equipment, for example:



- Fans
- Cogs
- Rollers
- Shafts
- Wire spools and welding wire

By product

Many harmful phenomena, such as noise, bright light and harmful gas, will inevitably occur in the welding process. In order to avoid harmful phenomena causing harm to the human body, it is necessary to make corresponding preparations in advance.

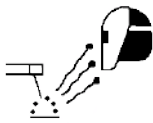

Arc rays from the welding process produce intense visible and invisible ultraviolet and infrared rays that can burn eyes and skin.

- Use a shield with the proper filter and cover plates to protect your eyes from sparks and the rays of the arc when welding or observing open arc welding.
- Use suitable clothing made from durable flame-resistant material to protect your skin and that of your helpers from the arc rays.
- Protect other nearby personnel with suitable, non-flammable screening and/or warn them not to watch the arc nor expose themselves to the arc rays or to hot spatter or metal.



Noise from some processes or equipment can damage hearing. You must protect your ears from loud noise to prevent permanent loss of hearing.

- To protect your hearing from loud noise, wear protective ear plugs and/or ear muffs. Protect others in the workplace.
- Noise levels should be measured to be sure the decibels (sound) do not exceed safe levels.



The build up of gas can cause a toxic environment, deplete the oxygen content in the air resulting in death or injury. Many gases used in welding are invisible and odorless.

- Shut off shielding gas supply when not in use.
- Always ventilate confined spaces or use approved air-supplied respirator.

Welding may produce fumes and gases hazardous to health. Avoid breathing these fumes and gases.



- Do not breathe the smoke and gas generated whilst welding or cutting, keep your head out of the fumes. Use enough ventilation and/or exhaust at the arc to keep fumes and gases away from the breathing zone. Additional precautions are also required when welding on galvanized steel.
 - Do not weld in locations near chlorinated hydrocarbon vapors coming from degreasing, cleaning or spraying operations. The heat and rays of the arc can react with solvent vapors to form phosgene, a highly toxic gas, and other irritating products.
 - Shielding gases used for arc welding can displace air and cause injury or death. Always use enough ventilation, especially in confined areas, to insure breathing air is safe.
 - Read and understand the manufacturer's instructions for this equipment and the consumables to be used, including the material safety data sheet and follow your employer's safety practices.
-

Explosion

In the process of using, careless operation will lead to fire, explosion and gas leakage or other dangers. Before using the product, we need to know the correct preventive measures in order to avoid accidents.



Don't add the fuel near an open flame welding arc or when the engine is running. Stop the engine and allow it to cool before refueling to prevent spilled fuel from vaporizing on contact with hot engine parts and igniting.

Do not spill fuel when filling tank. If fuel is spilled, wipe it up and do not start engine until fumes have been eliminated.

Flying sparks from the welding arc, hot work piece, and hot equipment can cause fires and burns. Accidental contact of electrode to metal objects can cause sparks, explosion, overheating or fire.

- Welding sparks and hot materials from welding can easily go through small cracks and openings to adjacent areas.
- Avoid welding near hydraulic lines.
- Have a fire extinguisher readily available. Where compressed gases are to be used at the job site, special precautions should be used to prevent hazardous situation.
- Vent hollow castings or containers before heating, cutting or welding. They may explode.
- Sparks and spatter are thrown from the welding arc. Wear oil free protective garments such as leather gloves, heavy shirt, cuff less trousers, high shoes and a cap over your hair.
- Connect the work cable to the work as close to the welding area as practical. Work cables connected to the building framework or other locations away from the welding area increase the possibility of the welding current passing through lifting chains, crane cables or other alternate circuits. This can create fire hazards or overheat lifting chains or cables until they fail.

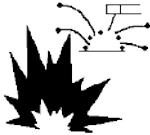

Shielding gas cylinders contain gas under high pressure. If damaged, a cylinder can explode.

- Protect gas cylinders from excessive heat, mechanical shocks, physical damage, slag, open flames sparks, and arcs.
- Insure cylinders are held secure and upright to prevent tipping or falling over.
- Never allow the welding electrode or earth clamp to touch the gas cylinder, do not drape welding cables over the cylinder.
- Open the cylinder valve slowly and turn your face away from the



cylinder outlet valve and gas regulator.



Cylinder

Use only compressed gas cylinders containing the correct shielding gas for the process used and properly operating regulators designed for the gas and pressure used. All hoses, fittings, etc. should be suitable for the application and maintained in good condition.

- Always keep cylinders in an upright position securely chained to an undercarriage or fixed support.
- Cylinders should be located:
 - Away from areas where they may be struck or subjected to physical damage.
 - A safe distance from arc welding or cutting operations and any other source of heat, sparks, or flame.
- Never allow the electrode, electrode holder or any other electrically “hot” parts to touch a cylinder.
- Keep your head and face away from the cylinder valve outlet when opening the cylinder valve.
- Valve protection caps should always be in place and hand tight except when the cylinder is in use or connected for use.

Electricity

Touching live electrical parts can cause fatal shocks or severe burns. The electrode and work circuit is electrically live whenever the output is on. The input power circuit and internal machine circuits are also live when power is on.



Different products have different requirements for input voltage, such as single-phase and three-phase. If the machine with three-phase electricity as input appears phase absence or voltage fluctuation, it may cause serious damage to the product interior.



All products must be well grounded before they are connected to the power supply. In case of abnormal case such as shell leakage, please disconnect the power supply immediately and notify the professionals for

maintenance.



Don't sling cables or leads around either the body or parts of the body.

The electrode (rod electrode, tungsten electrode, welding wire, etc) must

- Never be immersed.
- Never be touched when current is flowing.



When the machine is connected to the power supply, there is electricity inside the machine. Please do not touch the wires, circuit boards and related electrical parts in order to avoid life hazards and property losses.



During MIG/MAG or TIG welding, the welding wire, the wire spool, the drive rollers and all metal parts that are in contact with the welding wire are live. Always set the wire-feed unit up on a sufficiently insulated surface or use a suitable, insulated wire-feed unit mount.

According to the domestic and international standards, the ambient devices' electromagnetism situation and anti-interference ability must be checked:

- Safety device.
- Power line, Signal transmission line and Data transmission line.
- Data processing equipment and telecommunication equipment.
- Inspection and calibration device.



EMC

Supporting measures for avoidance of EMC problems:

1. Mains supply

If electromagnetic interference arises despite correct mains connection, additional measures are necessary.

2. Welding power leads must be kept as short as possible, must run close together and be kept well apart from other leads

3. Equipotential bonding

4. Earthing of the workpiece

If necessary, establish an earth connection using suitable capacitors.

5. Shielding, if necessary

- Shield off other nearby devices.

- Shield off entire welding installation.
-

Radiation Class A Device.

- Only can be used in the industrial area.
- If it is used in other area, it may cause connection and radiation problems of circuit.

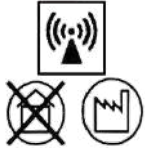

EMC Class

Radiation Class B device.

- Satisfy the emissions criteria for residential and industrial areas. This is also true for residential areas in which the energy is supplied from the public low-voltage mains.

EMC device classification as per the rating plate or technical data.

§2 SUMMARY

§2.1 Brief Introduction

TIG DC PULSE welding machine adopts the latest pulse width modulation (PWM) technology and insulated gate bipolar transistor (IGBT) power module, which can change work frequency to medium frequency so as to replace the traditional hulking work frequency transformer with the cabinet medium frequency transformer. Thus, it is characterized with portable, small size, light weight, low consumption and etc.

The parameters of TIG DC PULSE on the front panel all can be adjusted continuously and steplessly, such as start current, crater arc current, welding current, base current, duty ratio, upslope time, downslope time, pre-gas, post-gas, pulse frequency, hot start, arc force and arc length etc. When welding, it takes high frequency and high voltage for arc igniting to ensure the success ratio of igniting arc.

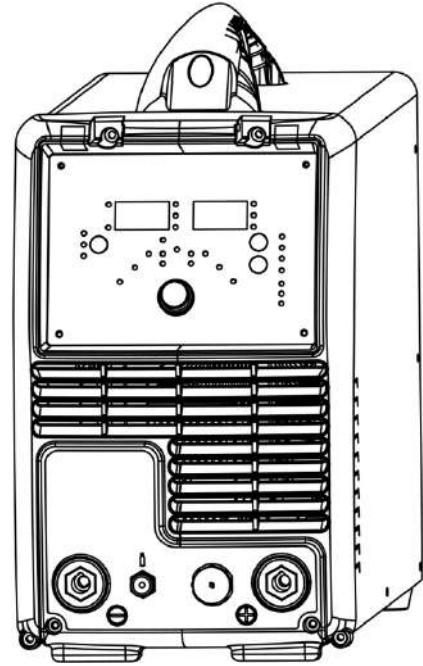

TIG DC PULSE Characteristics:

- ★ **DC Pulsed TIG and MMA, adopt IGBT and advanced PWM technology;**
 - ★ **High performance MCU, Digital control, Digital display;**
 - ★ **Preset all parameters with holding process;**
 - ★ **HF/Lift TIG, current down slope and up slope, gas post-flow, Pulse Frequency**
 - ★ **Intelligent protection: over-voltage, over-current, over-heat, when the problems listed before occurred, the alarm indicator on the front panel will be on and the output current will be cut off. It can self-protect and prolong the using life.**
1. For MMA, polarity connection can be chosen according to different electrodes, please refer to §3.3.1;
 2. For DC TIG, DCEP is used normally (workpiece connected to positive polarity, while torch connected to negative polarity). This connection has many characters, such as stable welding arc, low tungsten pole loss, more welding current, narrow and deep

weld;

3. DC Pulsed TIG has the following characters:

- 1) Pulse heating. Metal in Molten pool has short time on high temperature status and freezes quickly, which can reduce the possibility to produce hot crack of the materials with thermal sensitivity.
- 2) The workpiece gets little heat. Arc energy is focused. Be suitable for thin sheet and super thin sheet welding.
- 3) Exactly control heat input and the size of the molten pool. The depth of penetration is even. Be suitable for welding by one side and forming by two sides and all position welding for pipe.
- 4) High frequency arc can make metal for microlite fabric, eliminate blowhole and improve the mechanical performance of the joint.
- 5) High frequency arc is suitable for high welding speed to improve the productivity.

TIG DC PULSE-series welding machine is suitable for all positions welding for various plates made of stainless steel, carbon steel, alloyed steel, titanium, magnesium, cuprum, etc, which is also applied to pipe installment, mould mend, petrochemical, architecture decoration, car repair, bicycle, handicraft and common manufacture.

MMA—Manual Metal Arc welding

PWM—Pulse-Width Modulation

IGBT—Insulation Gate Bipolar Transistor

TIG—Tungsten Insert Gas welding

§2.2 Parameters

Parameters \ Models	TIG 320 DC PULSE		TIG 400 DC PULSE	
Power source	3-400V±10%, 50/60Hz			
	TIG	MMA	TIG	MMA
Rated input current (A)	18.0	23.8	24.3	32.2
Rated input power (KW)	12.5	16.5	16.9	22.3
Power factor	0.70			
Welding current range (A)	10~320		10~400	
Max no load voltage (V)	72.5	72.6	74.1	
Up slope/Down slope (S)	0~10			
Pre/Post Flow (S)	0~2.0/0~10.0			
Pulse Frequency (HZ)	0.5~999			
Pulse Width Range (%)	5~95			
Efficiency (%)	≥85		≥80	
Duty cycle (40°C, 10mins)	60% 320A 100% 250A		60% 400A 100% 310A	
Circuit breaker	LW31-32B-4AB-04/2			
Protection class	IP21S			
Cooling	AF			
Net weight (Kg)	26		26	
Dimensions (mm)	610×240×440			

Note: The above parameters are subject to change with the improvement of machines.

§2.3 Duty cycle & Over heat

The letter “X” stands for duty cycle, which is defined as the proportion of the time that a machine can work continuously within a certain time (10 minutes). The rated duty cycle means the proportion of the time that a machine can work continuously within 10 minutes when it outputs the rated welding current.

The relation between the duty cycle “X” and the output welding current “I” is shown as the right figure.

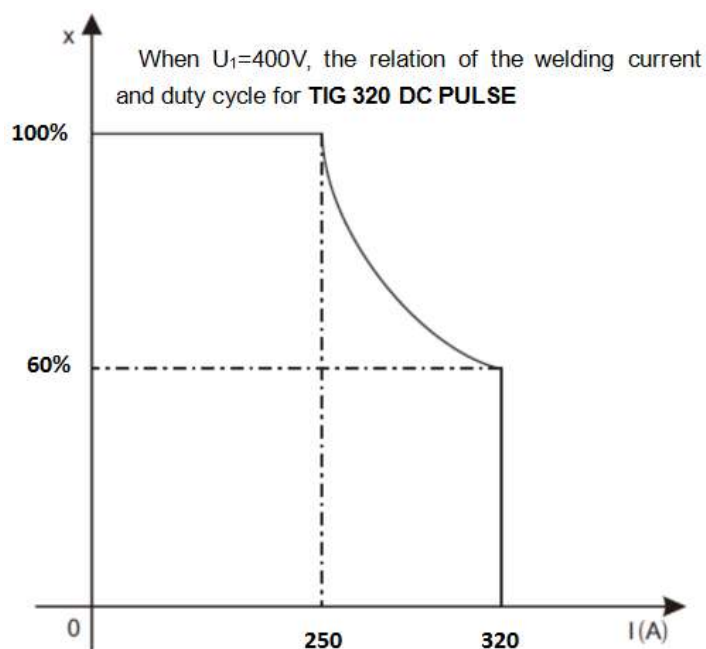

If the welder is over-heat, the IGBT over-heat protection unit inside it will output an instruction to cut output welding current, and brighten the over-heat pilot lamp on the front panel. At this time, the machine should be relaxed for 15 minutes to cool the fan. When operating the machine again, the welding output current or the duty cycle should be reduced.

§2.4 Working Principle

The working principle of TIG DC PULSE-series welding machines is shown as the following figure. Three phases work frequency AC 400V (50 Hz) is rectified into DC (530V), then is converted to medium frequency AC (about 20KHZ) by inverter device (IGBT), after reducing voltage by medium transformer (the main transformer) and rectifying by medium frequency rectifier (fast recovery diode), and is outputted by inductance filtering. The circuit adopts current feedback control technology to insure current output stably. Meanwhile, the welding current parameter can be adjusted continuously and steplessly to meet with the requirements of welding craft.

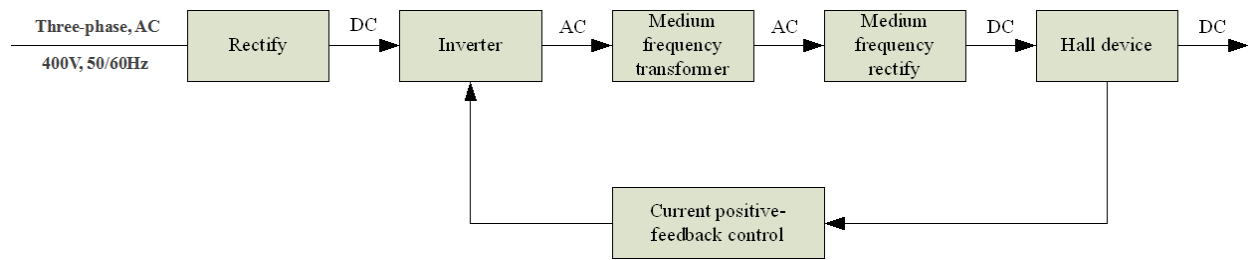

§2.5 Volt-Ampere Characteristic

TIG DC PULSE welding machine has an excellent volt-ampere characteristic, whose graph is shown as the following figure. The relation between the conventional rated loading voltage U_2 and the conventional welding current I_2 is as follows:

When $I_2 \leq 600\text{A}$, $U_2 = 10 + 0.04I_2(\text{V})$; When $I_2 > 600\text{A}$, $U_2 = 34(\text{V})$.

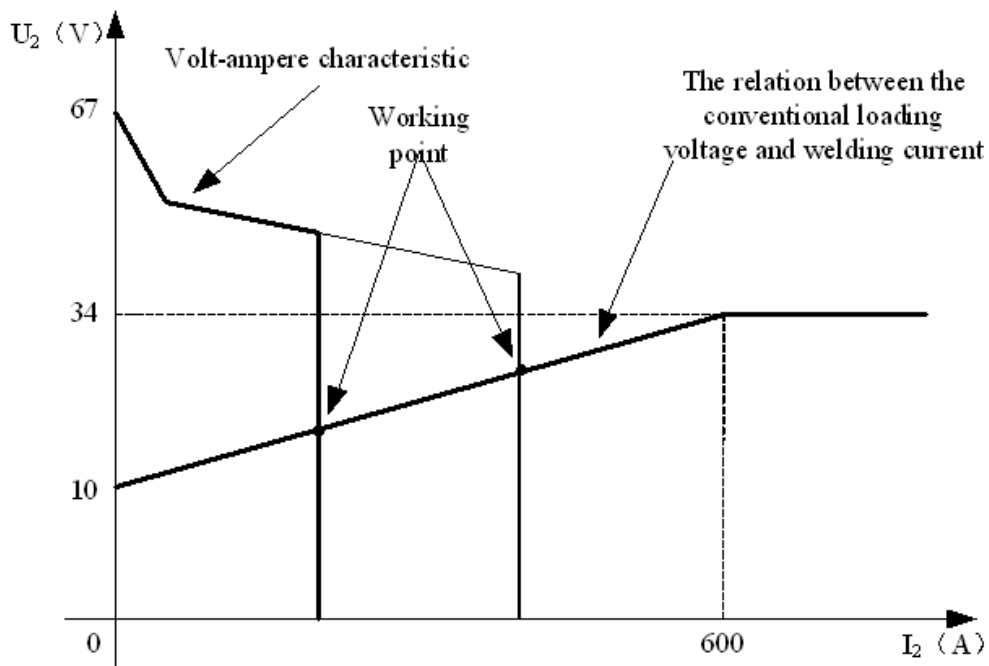

§3 Installation & Operation

§3.1 Layout for Front and Rear panel

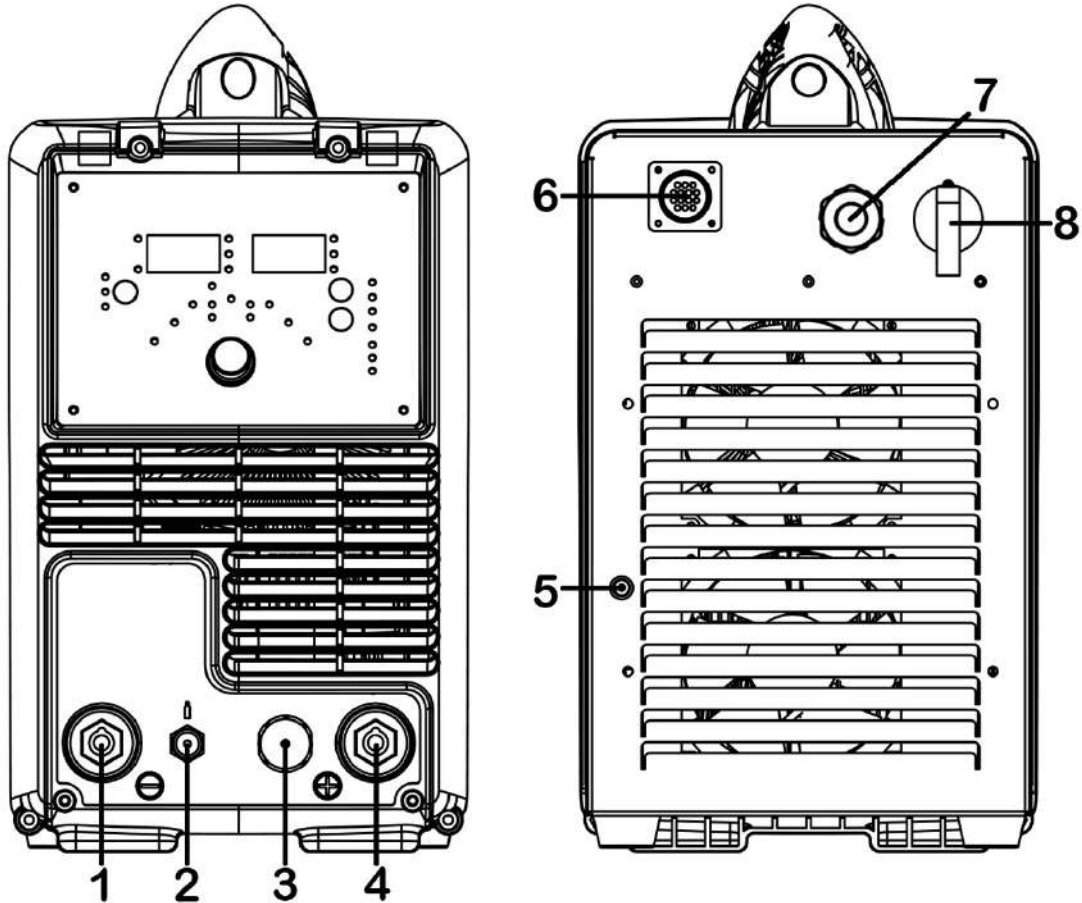

- 1 **Negative output:** The welder's negative polarity output.
- 2 **Shield gas connector:** Is connected to the gas input pipe of torch.
- 3 **12-PIN air socket:** Is connected to torch switch control wire.
- 4 **Positive output:** The welder's positive polarity output.
- 5 **Shield gas input joint:** To connect one head of the gas hose while the other head of which is connected to argon gas cylinder.
- 6 **Water box connector:** Is connected to the water box.
- 7 **Power source input:** To connect power source.
- 8 **Power source switch:** Switch to "ON", the welder is turned on, while switch to "OFF", the welder is turned off.

§3.2 Layout for Control panel

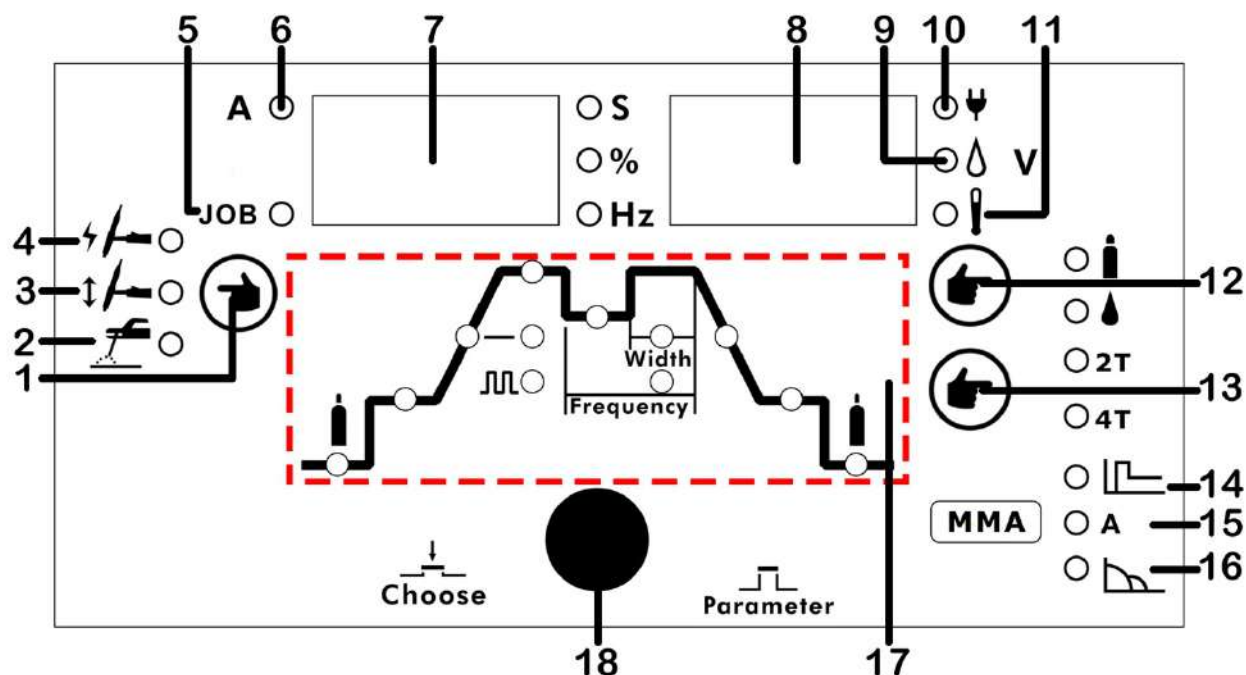

1. **Welding mode selecting button:** Can select HF/LIFT TIG or MMA welding mode.
2. **MMA welding mode indicator.**
3. **LIFT TIG welding mode indicator.**
4. **HF TIG welding mode indicator:** HF= high frequency.
5. **JOB indicator.***
6. **Welding current indicator.**
7. **LH display.***
8. **RH display.***
9. **Water-break indicator:** When water cooling selected and no water flow, it lights on.
10. **Power indicator:** It lights when input power connected and machine switched on.
11. **Alarm indicator:** When the machine is over-current, over-voltage, over-heat, the indicator light on.*
12. **Cooling mode select button:** Select air cooling or water cooling.
13. **2T/4T trigger mode select button:** Can select 2T mode or 4T mode.*
14. **Hot start indicator.***
15. **MMA current indicator.**
16. **Arc force indicator.***
17. **TIG parameter setting:** Here are 12 indicators about TIG welding mode.*
18. **Control knob:** Press down the knob to choose parameter, rotate the knob to adjust

value of current or parameter.

***Denotes more detailed explanation of function to follow.**

Further Controls Explained:

Program/Job Memory (5)

TIG series of welding machines has 9 memory/job spaces that parameters can be saved to for easy recall. To access a saved program, press the control knob (18) for 2 seconds and the program number 1~9 will show on LH display. Adjust to the program number required by rotating the control knob. Once the program is accessed, it will automatically load. To return to normal parameter settings, press the control knob for 2 seconds again. To save parameters set as a program, press and hold the control knob for a few seconds and the display will blink. The settings are now saved in the last program space that was selected. If setting parameters to save as a program, ensure that you start with a program number that the data is OK to over write, as the previous settings saved to that memory space will be lost.

LH Display (7)

Before welding this displays the setting selected/being adjusted using the control knob (18). During welding it displays welding current. The parameter setting displayed is indicated by the indicators below the display; percentage (%), Current (A), Time (S) and Frequency (Hz). If left inactive for several seconds, display will revert back to main welding current setting.

RH Digital Multifunction Display (8)

Before welding, this display secondary functions and error codes. During welding it displays welding voltage.

Alarm Indicator (11)

Lights when over voltage, over current or electrical overheating (due to exceeding duty

cycle) is detected and protection is activated. When protection is activated, welding output will be disabled until the safety system senses the overload has reduced sufficiently and indicator lamp goes out. May also trigger if machine experiences an internal power circuit failure.

MMA settings

Hot start (14)

Hot start provides extra power when the weld starts to counteract the high resistance of the electrode and workpiece as the arc is started. Setting range: 0~10.

Arc force (16)

An MMA welding power source is designed to produce constant output current (CC). This means with different types of electrode and arc length; the welding voltage varies to keep the current constant. This can cause instability in some welding conditions as MMA welding electrodes will have a minimum voltage they can operate with and still have a stable arc.

Arc Force control boosts the welding power if it senses the welding voltage is getting too low. The higher the arc force adjustment, the higher the minimum voltage that the power source will allow. This effect will also cause the welding current to increase. 0 is Arc Force off, 10 is maximum Arc Force. This is practically useful for electrode types that have a higher operating voltage requirement or joint types that require a short arc length such as out of position welds.

TIG Settings

2T/4T trigger mode select button (13)

● 2T Mode

The trigger is pulled and held on to activate the welding circuit, when the trigger is released, the welding circuit stops.

This function without the adjustment of start current and crater current is suitable for the Re-tack welding, transient welding, thin plate welding and so on.

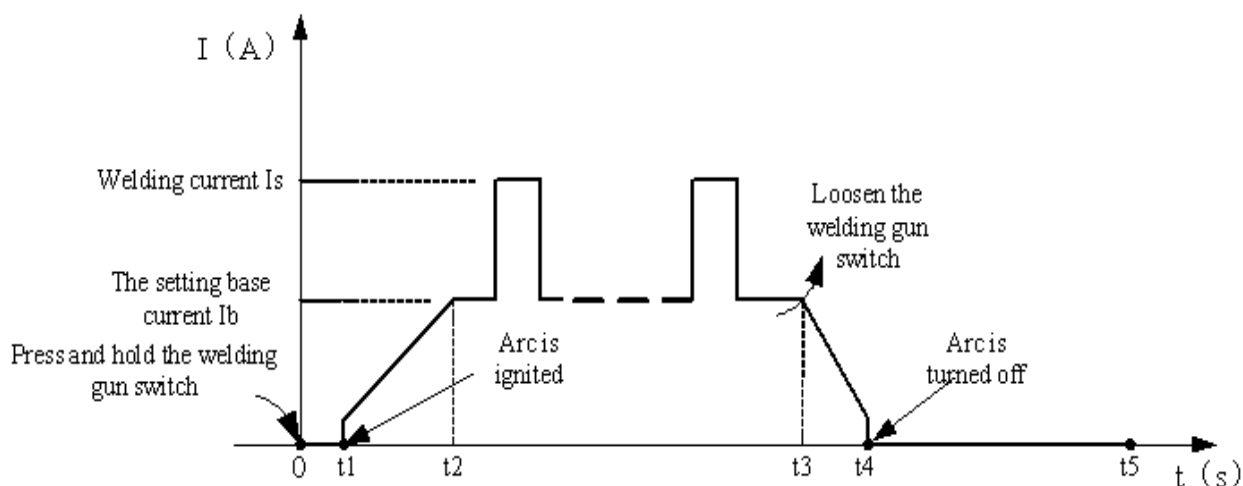

Introduction:

- (1) 0: Press the gun switch and hold it. Electromagnetic gas valve is turned on. The shielding gas starts to flow.
- (2) 0~t1: Pre-gas time (0.1~2.0S)
- (3) t1~t2: Arc is ignited and the output current rises to the setting welding current (I_w or I_b) from the min welding current.
- (4) t2~t3: During the whole welding process, the gun switch is pressed and held without releasing.

Note: Select the pulsed output, the base current and welding current will be outputted alternately; otherwise, output the setting value of welding current;

- (5) t3: Release the gun switch, the welding current will drop in accordance with the selected down-slope time.
- (6) t3~t4: The current drops to the minimum welding current from the setting current (I_w or I_b), and then arc is turned off.
- (7) t4~t5: Post-gas time, after the arc is turned off. You can adjust it (0.0~10S) through turning the knob on the front panel.
- (8) t5: Electromagnetic gas valve turned off, the shield gas stops to flow, and welding is finished.

● **4T Mode**

This is known as 'latching' mode. The trigger is pulled once and released to activate the welding circuit, pulled and released again to stop the welding circuit. This function is useful to longer welds as the trigger is not required to be held on continuously. TIG series

of welding machines also has more current control options that can be used in 4T mode.

The start current and crater current can be pre-set. This function can compensate the possible crater that appears at the beginning and end of the welding. Thus, 4T is suitable for the welding of medium thickness plates.

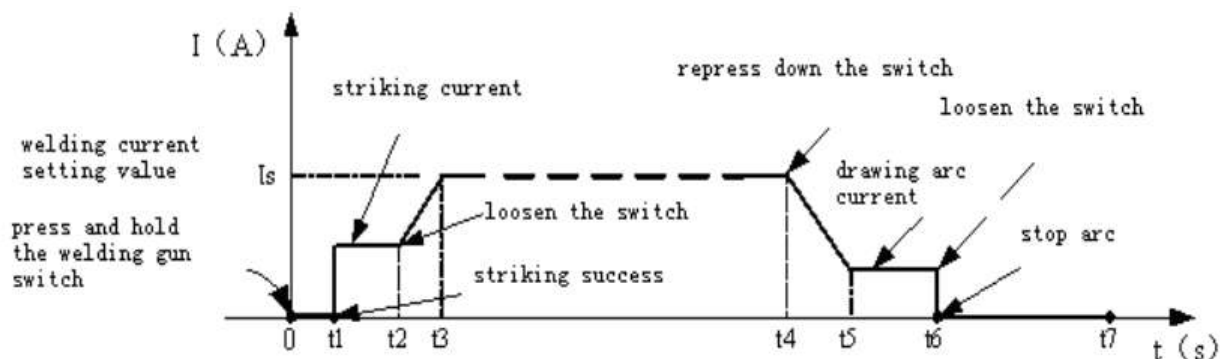

Introduction:

- (1) 0: Press and hold the gun switch, Electromagnetic gas valve is turned on. The shielding gas starts to flow;
 - (2) 0~ t_1 : Pre-gas time (0.1~2.0S);
 - (3) t_1 ~ t_2 : Arc is ignited at t_1 and then output the setting value of start current;
 - (4) t_2 : Loosen the gun switch, the output current slopes up from the start current;
 - (5) t_2 ~ t_3 : The output current rises to the setting value (I_w or I_b), the upslope time can be adjusted;
 - (6) t_3 ~ t_4 : Welding process. During this period, the gun switch is loosen;
- Note:** Select the pulsed output, the base current and welding current will be outputted alternately; otherwise, output the setting value of welding current;
- (7) t_4 : Press the torch switch again, the welding current will drop in accordance with the selected down-slope time.
 - (8) t_4 ~ t_5 : The output current slopes down to the crater current. The downslope time can be adjusted;
 - (9) t_5 ~ t_6 : The crater current time;
 - (10) t_6 : Loosen the gun switch, stop arc and keep on argon flowing;
 - (11) t_6 ~ t_7 : Post-gas time can be set by the post-gas time adjustment knob on the front panel (0.0~10S);
 - (12) t_7 : Electromagnetic valve is closed and stop argon flowing. Welding is finished.

TIG Parameter Setting (17)

In TIG mode, switch between welding parameter settings (pre gas, start current, up slop) by pressing the knob (18), parameter/setting selected will be indicated by the indicator on the control panel and the value shown on the LH display (7). Adjust the parameter by turning the knob. If left inactive for several seconds, display will revert back to main welding current setting. Switch between pulse and no pulse by turning the knob.

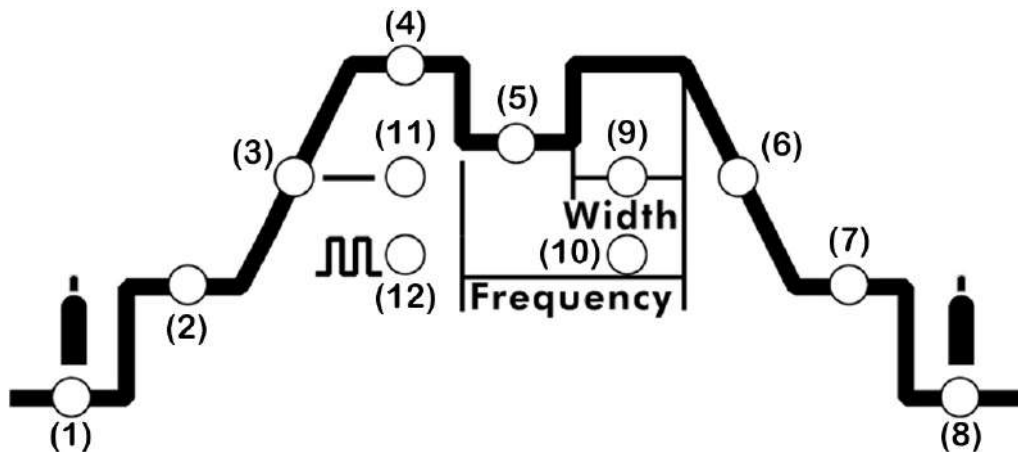

- **Pre gas flow setting indicator (1)**

Pre-flow controls the period shielding gas will flow for when the torch is triggered before the arc starts. This purges the work area of atmospheric gas which could contaminate the weld before the weld starts. Unit (S) and setting range (0.1~2.0S).

- **Start current setting indicator (2)**

Available in 4T trigger mode, sets a welding current 10~100% of the main welding current activated when the trigger is held on to 'latch' the trigger before the main weld current is started. Once the trigger is released, the current will go through the upslope (3) period if it is set, to the main welding current (4).

- **Up slope setting indicator (3)**

When the trigger is activated, the welding current will increase gradually over the time selected up to the set main welding current (4). Unit (S) and setting range (0~10.0S).

- **TIG welding current setting indicator (4)**

Set the main welding current. Unit (A) and setting range (10~320A/400A).

- **Base current setting indicator (5)**

Only be available when pulse mode (12) is selected. Set the current of the low/base

pulse. Unit (A) and setting range (10~320A/400A).

- **Down slope setting indicator (6)**

When the trigger is released, the welding current will reduce gradually over the time selected down to 0. This allows the operator to complete the weld without leaving a 'crater' at the end of the weld pool. Unit (S) and setting range (0~10.0S).

- **End current setting indicator (7)**

Available in 4T trigger mode only, sets a welding current 5~100% of the main welding current activated when the trigger is held on to 'unlatch' the trigger before the weld is finished. If downslope (6) is set, the current will go through the downslope period before going to the end current set. When the trigger is released, the arc will stop.

- **Post gas flow setting indicator (8)**

Controls the period of time the shielding gas continues to flow for after the arc is stopped. This protects the weld area and torch tungsten from contamination while it is still hot enough to react with atmospheric gases, after the weld is finished. Unit (S) and setting range (0~10.0S).

- **Pulse width setting indicator (9)**

Only be available when pulse mode (12) is selected. Set the time proportion as a percentage between the peak current and base current when using pulse mode. Neutral setting is 50%, the time period of the peak current and base current pulse is equal. Higher pulse duty setting will give greater heat input, while lower pulse duty will have the opposite effect. Unit (%) and setting range (5~95%).

- **Pulse frequency setting indicator (10)**

Only be available when pulse mode (12) is selected. Set the rate that the welding output alternates between the peak and base current settings. Unit (Hz) and setting range (0.5~999Hz).

- **Pulse mode 'off' indicator (11)**

- **Pulse mode 'On' indicator (12)**

§3.3 Installation & Operation for MMA welding

§3.3.1 Set up installation for MMA Welding

Connection of Output Cables

Two sockets are available on this welding machine. For MMA welding the electrode holder is shown be connected to the positive socket, while the earth lead (work piece) is connected to the negative socket, this is known as DCEP. However various electrodes require a different polarity for optimum results and careful attention should be paid to the polarity, refer to the electrode manufacturer's information for the correct polarity.

DCEP: Electrode connected to “+” output socket.

DCEN: Electrode connected to “-” output socket.

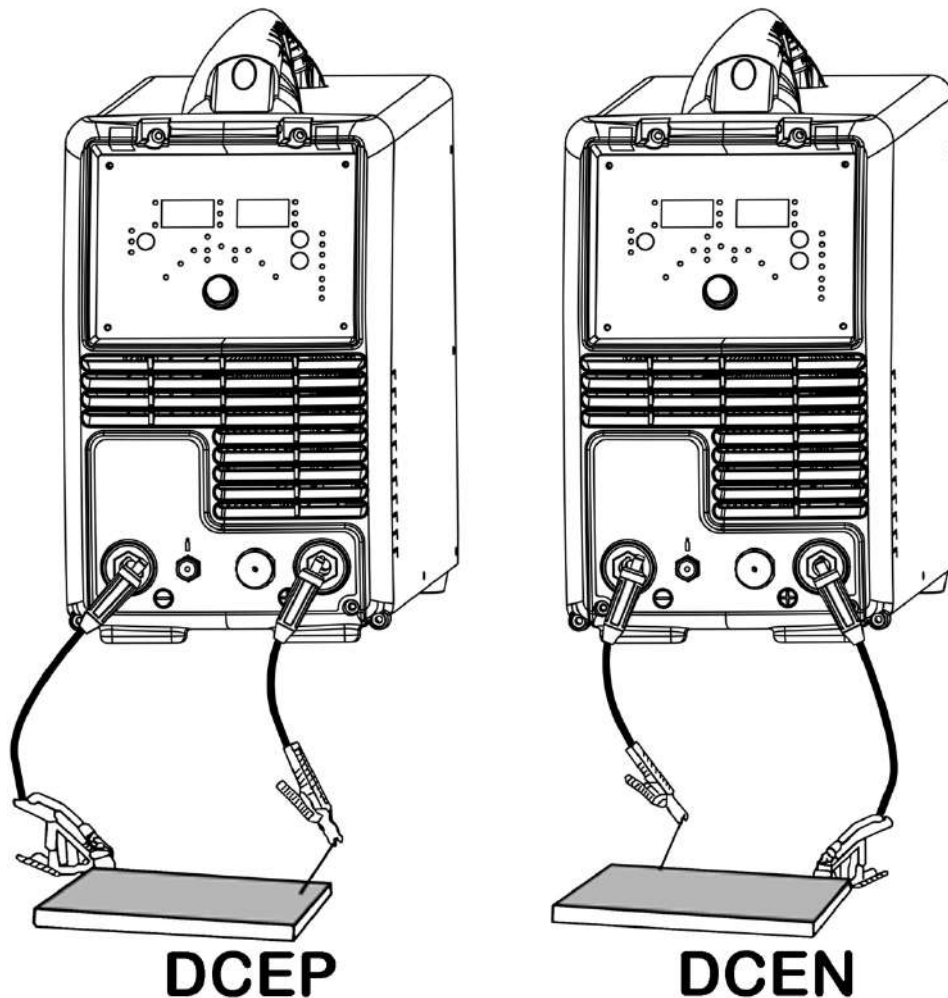

- (1) Connect the earth lead to “-”, tighten clockwise;
- (2) Connect the earth clamp to the work piece. Contact with the work piece must be firm contact with clean, bare metal, with no corrosion, paint or scale at the contact point.

- (3) Connect the electrode lead to “+”, tighten clockwise;
- (4) Each machine is equipped with a power cable should be based on the input voltage welding power cable connected to the appropriate position, not to pick the wrong voltage;
- (5) With the corresponding input power supply terminal or socket good contact and prevent oxidation;
- (6) With a multi meter measure the input voltage is within the fluctuation range;
- (7) The power ground is well grounded.

§3.3.2 Operation for MMA Welding

- (1) According to the above method to install is correct, turn the power switch, so that the power switch is “ON” position, then the power indicator light, the fan comes on, the device work properly.
- (2) Set to ‘MMA’ welding mode.
- (3) Set the welding parameters as required using the parameters control knob (following the instructions in the previous section).
- (4) Place the electrode into the electrode holder and clamp tight.
- (5) Strike the electrode against the work piece to create and arc and hold the electrode steady to maintain the arc.
- (6) Commence welding. If necessary, readjust the Welding parameters control knob to obtain the welding condition required.
- (7) After completion of welding the Power Source should be left turned ON for 2 to 3 minutes. This allows the fan to run and cool the internal components.
- (8) Switch the ON/OFF Switch to the OFF position.

NOTE:

- Note the polarity of wiring, the general DC welding wire in two ways. Selected according to the technical requirements of welding the appropriate connection, if you choose incorrectly will result in arc instability and spatter large adhesion and other phenomena, such cases can be quickly reversed to joints.
- If the work piece distance from the welding machine, the second line (electrode

holder and ground) is longer, so choose the appropriate conductor cross-sectional area should be larger to reduce cable voltage drop.

§3.3.3 MMA Welding

One of the most common types of arc welding is manual metal arc welding (MMA) or stick welding. An electric current is used to strike an arc between the base material and a consumable electrode rod or 'stick'. The electrode rod is made of a material that is compatible with the base material being welded and is covered with a flux that gives off gaseous vapours that serve as a shielding gas and providing a layer of slag, both of which protect the weld area from atmospheric contamination. The electrode core itself acts as filler material the residue from the flux that forms slag covering over the weld metal must be chipped away after welding.

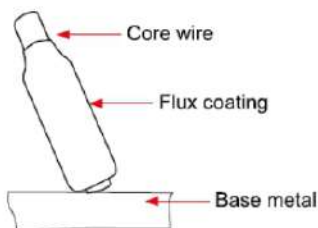
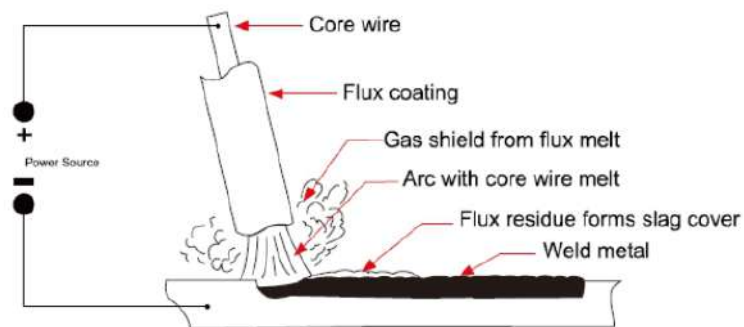

- The arc is initiated by momentarily touching the electrode to the base metal.
- The heat of the arc melts the surface of the base metal to form a molten pool at the end of the electrode.
- The melted electrode metal is transferred across the arc into the molten pool and becomes the deposited weld metal.

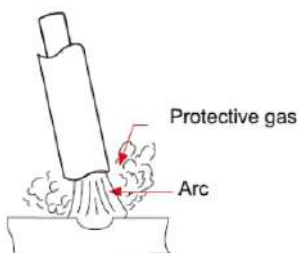

- The deposit is covered and protected by a slag which comes from the electrode coating.
- The arc and the immediate area are enveloped by an atmosphere of protective gas.

Manual metal arc (stick) electrodes have a solid metal wire core and a flux coating. These electrodes are identified by the wire

diameter and by a series of letters and numbers. The letters and numbers identify the metal alloy and the intended use of the electrode.

The **Metal Wire Core** works as conductor of the current that maintains the arc. The core wire melts and is deposited into the welding pool.

The covering on a shielded metal arc welding electrode is called **Flux**. The flux on the electrode performs many different functions. These include:

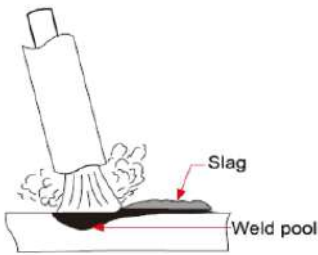

- producing a protective gas around the weld area
- providing fluxing elements and deoxidizer
- creating a protective slag coating over the weld as it cools
- establishing arc characteristics
- adding alloying elements

Covered electrodes serve many purposes in addition to filler metal to the molten pool. These additional functions are provided mainly by the covering on the electrode.

§3.3.4 MMA Welding Fundamentals

■ Electrode Selection

As a general rule, the selection of an electrode is straight forward, in that it is only a matter of selecting an electrode of similar composition to the parent metal. However, for some metals there is a choice of several electrodes, each of which has particular properties to suit specific classes of work. It is recommend to consult your welding supplier for the correct selection of electrode.

■ Electrode Size

Average Thickness of Material	Maximum Recommended Electrode Diameter
1.0~2.0 mm	2.5 mm
2.0~5.0 mm	3.2 mm
5.0~8.0 mm	4.0 mm
>8.0 mm	5.0 mm

The size of the electrode generally depends on the thickness of the section being welded, and the thicker the section the larger the electrode required. The table gives the

maximum size of electrodes that may be used for various thicknesses of section base on using a general purpose type 6013 electrode.

■ Welding Current (Amperage)

Electrode Size ø mm	Current Range (Amps)
2.5 mm	60~95
3.2 mm	100~130
4.0 mm	130~165
5.0 mm	165~260

Correct current selection for a particular job is an important factor in arc welding. With the current set too low, difficulty is experienced in striking and maintaining a stable arc. The electrode tends to stick to the work, penetration is poor and beads with a distinct rounded profile will be deposited. Too high current is accompanied by overheating of the electrode resulting in undercut and burning through of the base metal and producing excessive spatter. Normal current for a particular job may be considered as the maximum, which can be used without burning through the work, overheating the electrode or producing a rough spattered surface. The table shows current ranges generally recommended for a general purpose type 6013 electrode.

■ Arc Length

To strike the arc, the electrode should be gently scraped on the work until the arc is established. There is a simple rule for the proper arc length; it should be the shortest arc that gives a good surface to the weld. An arc too long reduces penetration, produces spatter and gives a rough surface finish to the weld. An excessively short arc will cause sticking of the electrode and result in poor quality welds. General rule of thumb for down hand welding is to have an arc length no greater than the diameter of the core wire.

■ Electrode Angle

The angle that the electrode makes with the work is important to ensure a smooth, even transfer of metal. When welding in down hand, fillet, horizontal or overhead the angle of the electrode is generally between 5 and 15 degrees towards the direction of travel.

When vertical up welding, the angle of the electrode should be between 80 and 90 degrees to the work piece.

■ **Travel Speed**

The electrode should be moved along in the direction of the joint being welded at a speed that will give the size of run required. At the same time, the electrode is fed downwards to keep the correct arc length at all times. Excessive travel speeds lead to poor fusion, lack of penetration etc, while too slow a rate of travel will frequently lead to arc instability, slag inclusions and poor mechanical properties.

■ **Material and Joint Preparation**

The material to be welded should be clean and free of any moisture, paint, oil, grease, mill scale, rust or any other material that will hinder the arc and contaminate the weld material. Joint preparation will depend on the method used include sawing, punching, shearing, machining, flame cutting and others. In all case, sedges should be clean and free of any contaminates. The type of joint will be determined by the chosen application.

§3.4 Installation & Operation for TIG welding

§3.4.1 Set up installation for TIG Welding

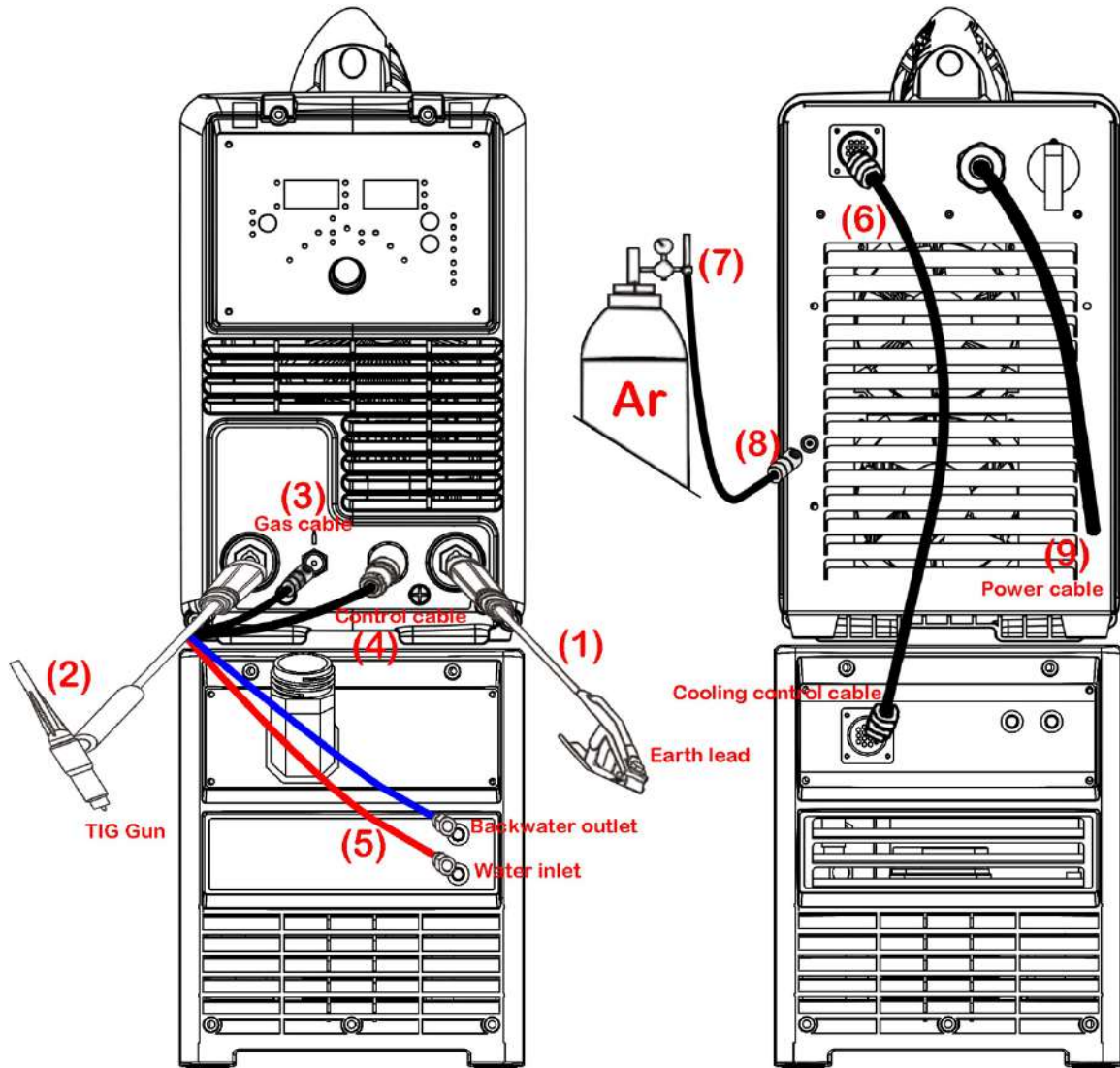

- (1) Insert the earth cable plug into the positive socket on the front of the machine and tighten it.
- (2) Plug the welding torch into the negative socket on the front panel, and tighten it.
- (3) Connect the gas line of TIG Gun to outlet gas connector on the front of the machine.
- (4) Connect the control cable of torch switch to 12 pin socket on the front of the machine.
- (5) Connect the water inlet and outlet pipe of TIG Gun to inlet and outlet water connector on the front of the water box.
- (6) Connect the control cable of water box with the aero socket on the rear panel of welding machine.

(7) Connect the gas regulator to the Gas Cylinder and connect the gas line to the Gas Regulator. **Check for Leaks!**

(8) Connect the gas line to the machine inlet gas connector via the quick push lock connector located on the rear panel. **Check for Leaks!**

NOTE: Air cooling mode without cooling device, and the water pipe is not needed for the air cooling mode.

(9) Connect the power cable of welding machine with the output switch in electric box on site. Turn on the power switch.

(10) Carefully open the valve of the gas cylinder, set the required gas flow rate.

(11) Select TIG function on the front panel.

(12) Set torch operation 2T/4T.

- When 2T operation is selected, press trigger Gas starts, touch and lift arc start. Release trigger Gas and Arc stops.
- When 4T operation is selected, press and release trigger Gas starts, touch and lift arc start. Press and release trigger again, Gas and Arc stops.

(13) Set up current and TIG parameter setting, including Pre Gas, Slow down, etc.

(14) Select cooling mode gas/water on the front panel.

§3.4.2 DC TIG Welding

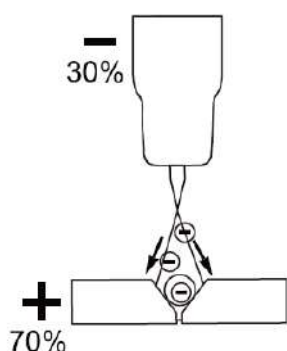

The DC power source uses what is known as DC (direct current) in which the main electrical component known as electrons flow in only one direction from the negative pole (terminal) to the positive pole (terminal). In the DC electrical circuit there is an electrical principle at work which should always be taken into account when using any DC circuit. With a DC circuit 70% of the energy (heat) is always on the positive side. This needs to be understood because it determines what terminal the TIG torch will be connected to (this rule applies to all the other forms of DC welding as well).

DC TIG welding is a process in which an arc is struck between a TUNGSTEN electrode and the metal work piece. The weld area is shielded by an inert gas flow to prevent

contamination of the tungsten, molten pool and weld area. When the TIG arc is struck the inert gas is ionized and superheated changing its molecular structure which converts it into a plasma stream. This plasma stream flowing between the tungsten and the work piece is the TIG arc and can be as hot as 19,000°C. It is a very pure and concentrated arc which provides the controlled melting of most metals into a weld pool. TIG welding offers the user the greatest amount of flexibility to weld the widest range of material and thickness and types. DC TIG welding is also the cleanest weld with no sparks or spatter.

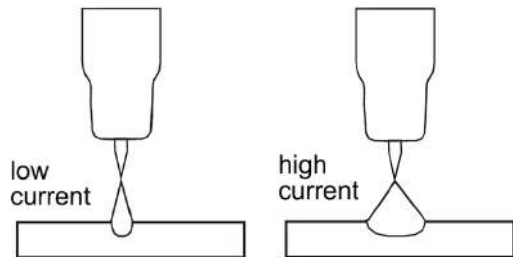
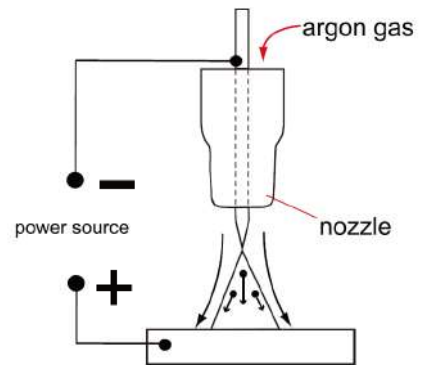

The intensity of the arc is proportional to the current that flows from the tungsten. The welder regulates the welding current to adjust the power of the arc. Typically thin material requires a less powerful arc with less heat to melt the material so less current (amps) is required, thicker material requires a more powerful arc with more heat so more current (amps) are necessary to melt the material.

§3.4.3 TIG Welding Fusion Technique

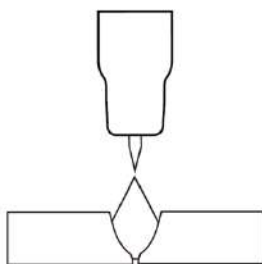

Manual TIG welding is often considered the most difficult of all the welding processes. Because the welder must maintain a short arc length, great care and skill are required to prevent contact between the electrode and the work piece. Similar to Oxygen Acetylene torch welding, TIG welding normally requires two hands and in most instances requires the welder to manually feed a filler wire into the weld pool with one hand while manipulating the welding torch in the other. However, some welds combining thin materials can be accomplished without filler metal like edge, corner, and butt joints. This is known as Fusion welding where the edges of the metal pieces are melted together using only the heat and arc force generated by the TIG arc. Once the arc is

started the torch tungsten is held in place until a weld pool is created, a circular movement of the tungsten will assist in creating a weld pool of the desired size. Once the weld pool is established tilt the torch at about a 75° angle and move smoothly and evenly along the joint while fusing the materials together.

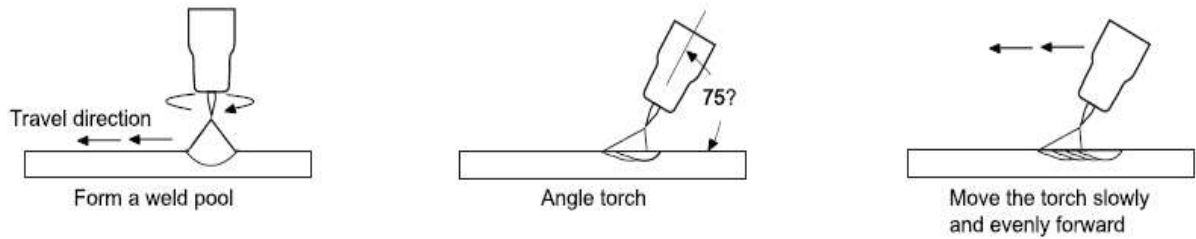

TIG Welding with Filler Wire Technique

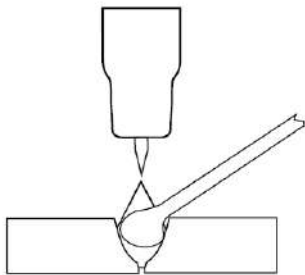

It is necessary in many situations with TIG welding to add a filler wire into the weld pool to build up weld reinforcement and create a strong weld. Once the arc is started the torch tungsten is held in place until a weld pool is created, a circular movement of the tungsten will assist in creating a weld pool of the desired size. Once the weld pool is established tilt the torch at about a 75° angle and move smoothly and evenly along the joint. The filler metal is introduced to the leading edge of the weld pool. The filler wire is usually held at about a 15° angle and fed into the leading edge of the molten pool, the arc will melt the filler wire into the weld pool as the torch is moved forward. Also a dabbing technique can be used to control the amount of filler wire added, the wire is fed into the molten pool and retracted in a repeating sequence as the torch is moved slowly and evenly forward. It is important during the welding to keep the molten end of the filler wire inside the gas shield as this protects the end of the wire from being oxidized and contaminating the weld pool

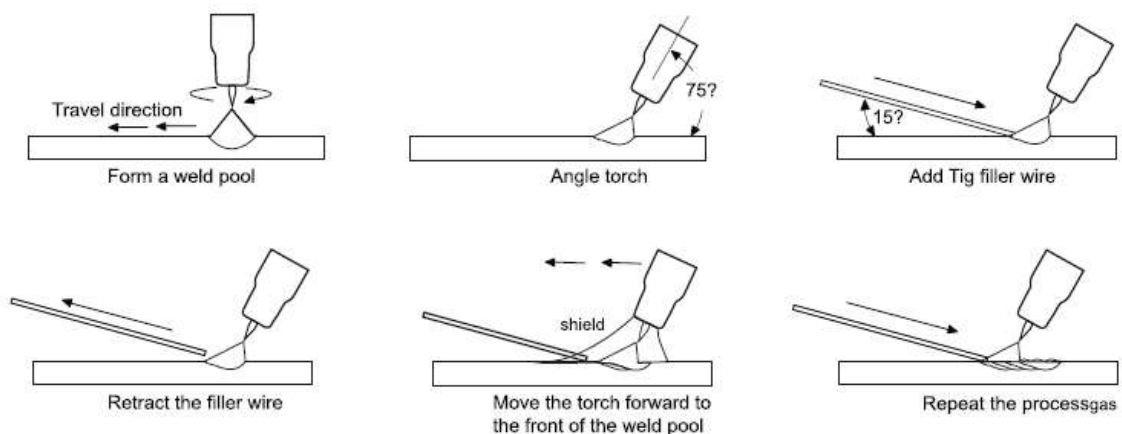

§3.4.4 Tungsten Electrodes

Tungsten is a rare metallic element used for manufacturing TIG welding electrodes. The TIG process relies on tungsten's hardness and high-temperature resistance to carry the welding current to the arc. Tungsten has the highest melting point of any metal, 3,410 degrees Celsius. Tungsten electrodes are non-consumable and come in a variety of sizes, they are made from pure tungsten or an alloy of tungsten and other rare earth elements. Choosing the correct tungsten depends on the material being welded, amps required and whether you are using AC or DC welding current. Tungsten electrodes are color-coded at the end for easy identification. Below are the most commonly used tungsten electrodes found in the New Zealand and Australian market.

Thoriated

Thoriated tungsten electrodes (AWS classification EWTh-2) contain a minimum of 97.30 percent tungsten and 1.70 to 2.20 percent thorium and are called 2 percent thoriated. They are the most commonly used electrodes today and are preferred for their longevity and ease of use. Thorium however is a low-level radioactive hazard and many users have switched to other alternatives. Regarding the radioactivity, thorium is an alpha emitter but when it is enclosed in a tungsten matrix the risks are negligible. Thoriated tungsten should not get in contact with open cuts or wounds. The more significant danger to welders can occur when thorium oxide gets into the lungs. This can happen from the exposure to vapours during welding or from ingestion of material/dust in the grinding of the tungsten. Follow the manufacturer's warnings, instructions, and the Material Safety Data Sheet (MSDS) for its use.

E3 (Color Code: Purple)

E3 tungsten electrodes (AWS classification EWG) contain a minimum of 98% percent tungsten and up to 1.5 percent Lanthanum and small percentages of Zirconium and Yttrium they are called E3 Tungsten. E3 Tungsten Electrodes provide conductivity similar to that of thoriated electrodes. Typically, this means that E3 Tungsten Electrodes are exchangeable with thoriated electrodes without requiring significant welding process

changes. E3 deliver superior arc starting, electrode lifetime, and overall cost-effectiveness. When E3 Tungsten Electrodes are compared with 2% thoriated tungsten, E3 requires fewer re-grinds and provides a longer overall lifetime. Tests have shown that ignition delay with E3 Tungsten Electrodes actually improves over time, while 2% thoriated tungsten starts to deteriorate after only 25 starts. At equivalent energy output, E3 Tungsten Electrodes run cooler than 2% thoriated tungsten, thereby extending overall tip lifetime. E3 Tungsten Electrodes work well on AC or DC. They can be used DC electrode positive or negative with a pointed end, or balled for use with AC power sources.

Ceriated (Color Code: Orange)

Ceriated tungsten electrodes (AWS classification EWCe-2) contain a minimum of 97.30 percent tungsten and 1.80 to 2.20 percent cerium and are referred to as 2 percent ceriated. Ceriated tungsten performs best in DC welding at low current settings. They have excellent arc starts at low amperages and become popular in such applications as orbital tube welding, thin sheet metal work. They are best used to weld carbon steel, stainless steel, nickel alloys, and titanium, and in some cases it can replace 2 percent thoriated electrodes. Ceriated tungsten is best suited for lower amperages it should last longer than Thoriated tungsten higher amperage applications are best left to Thoriated or Lanthanated tungsten.

Lanthanated (Color Code: Gold)

Lanthanated tungsten electrodes (AWS classification EWLa-1.5) contain a minimum of 97.80 percent tungsten and 1.30 percent to 1.70 percent lanthanum, and are known as 1.5 percent lanthanated. These electrodes have excellent arc starting, a low burn off rate, good arc stability, and excellent re-ignition characteristics. Lanthanated tungsten also share the conductivity characteristics of 2 percent thoriated tungsten. Lanthanated tungsten electrodes are ideal if you want to optimize your welding capabilities. They work well on AC or DC electrode negative with a pointed end, or they can be balled for use with AC sine wave power sources. Lanthanated tungsten maintains a sharpened point well, which is an advantage for welding steel and stainless steel on DC or AC from square wave power sources.

Zirconiated (Color Code: White)

Zirconiated tungsten electrodes (AWS classification EWZr-1) contain a minimum of 99.10 percent tungsten and 0.15 to 0.40 percent zirconium. Most commonly used for AC welding Zirconiated tungsten produces a very stable arc and is resistant to tungsten spitting. It is ideal for AC welding because it retains a balled tip and has a high resistance to contamination. Its current-carrying capacity is equal to or greater than that of thoriated tungsten. Zirconiated tungsten is not recommended for DC welding.

Tungsten Electrodes Rating for Welding Currents

Tungsten Diameter mm	DC Current Amps Torch Negative 2% Thoriated	AC Current Amps Un-Balanced Wave 0.8% Zirconiated	AC Current Amps Balanced Wave 0.8% Zirconiated
1.0mm	15~80	15~80	20~60
1.6mm	70~150	70~150	60~120
2.4mm	150~250	140~235	100~180
3.2mm	250~400	225~325	160~250
4.0mm	400~500	300~400	200~320

§3.4.5 Tungsten Preparation

Always use **DIAMOND** wheels when grinding and cutting. While tungsten is a very hard material, the surface of a diamond wheel is harder, and this makes for smooth grinding. Grinding without diamond wheels, such as Aluminum oxide wheels, can lead to jagged edges, imperfections, or poor surface finishes not visible to the eye that will contribute to weld inconsistency and weld defects.

Always ensure to grind the tungsten in a longitudinal direction on the grinding wheel. Tungsten electrodes are manufactured with the molecular structure of the grain running lengthwise and thus grinding crosswise is “grinding against the grain.” If electrodes are ground crosswise, the electrons have to jump across the grinding marks and the arc can start before the tip and wander. Grinding longitudinally with the grain, the electrons flow steadily and easily to the end of the tungsten tip. The arc starts straight and remains narrow, concentrated, and stable.



Electrode Tip/Flat

The shape of the tungsten electrode tip is an important process variable in precision arc welding. A good selection of tip/flat size will balance the need for several advantages. The bigger the flat, the more likely arc wander will occur and the more difficult it will be to arc start. However, increasing the flat to the maximum level that still allows arc start and eliminates arc wander will improve the weld penetration and increase the electrode life. Some welders still grind electrodes to a sharp point, which makes arc starting easier. However, they risk decreased welding performance from melting at the tip and the possibility of the point falling off into the weld pool.

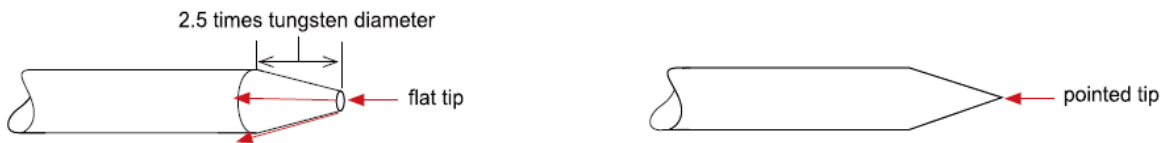

Electrode Included Angle/Taper - DC Welding

Tungsten electrodes for DC welding should be ground longitudinally and concentrically with diamond wheels to a specific included angle in conjunction with the tip/flat preparation. Different angles produce different arc shapes and offer different weld penetration capabilities. In general, blunter electrodes that have a larger included angle provide the following benefits:

- Last Longer
- Have better weld penetration
- Have a narrower arc shape
- Can handle more amperage without eroding.

Sharper electrodes with smaller included angle provide:

- Offer less arc weld
- Have a wider arc

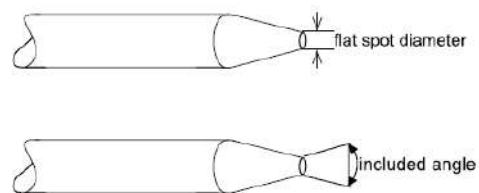

- Have a more consistent arc

The included angle determines weld bead shape and size. Generally, as the included angle increases, penetration increases and bead width decreases.

Tungsten Diameter	Diameter at the Tip - mm	Constant Included Angle - Degrees	Current Range Amps	Current Range Pulsed Amps
1.0mm	.250	20	5~30	5~60
1.6mm	.500	25	8~50	5~100
1.6mm	.800	30	10~70	10~140
2.4mm	.800	35	12~90	12~180
2.4mm	1.100	45	15~150	15~250
3.2mm	1.100	60	20~200	20~300
3.2mm	1.500	90	25~250	25~350

§3.4.6 Gun switch control current

UP/DOWN GUN

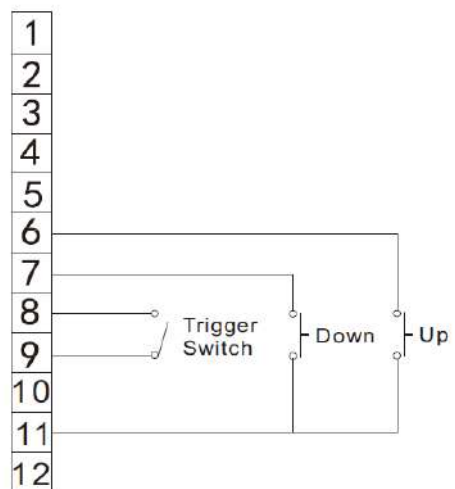
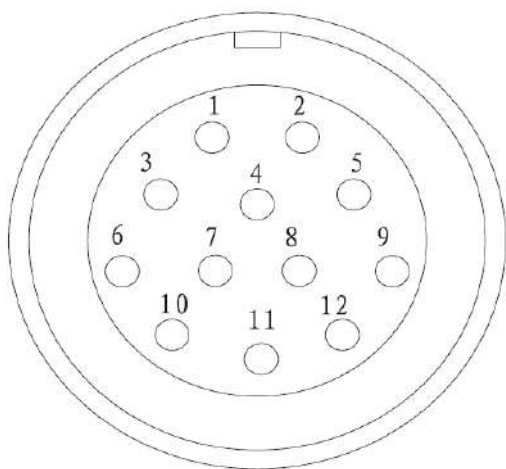
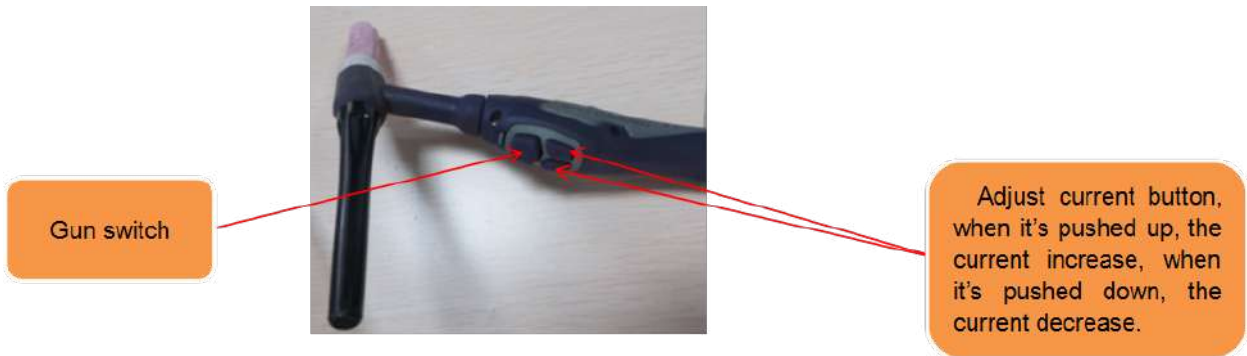

Remote Control Socket

Socket Pin	Function
1	Not connected
2	Not connected
3	Not connected
4	Not connected
5	Not connected
6	The button of "UP" input
7	The button of "DOWN" input
8	Trigger Switch Input
9	Trigger Switch Input
10	Not connected
11	The button of "UP"& "DOWN" input
12	Not connected

§3.4.7 Pedal switch control

- When plug the twelve-lead aero-socket of pedal switch in it. Welder will identify the pedal switch, the welding current knob on the front panel will can't use, and only 2T can be selected.
- When use the adjustment knob of max-welding current beside the pedal, can set the max-current you want.

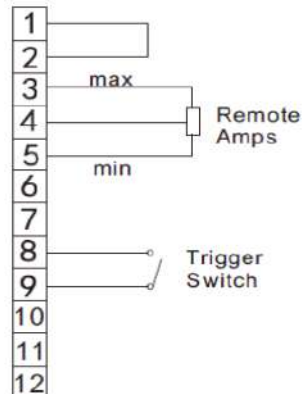
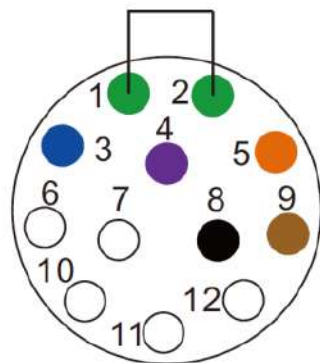
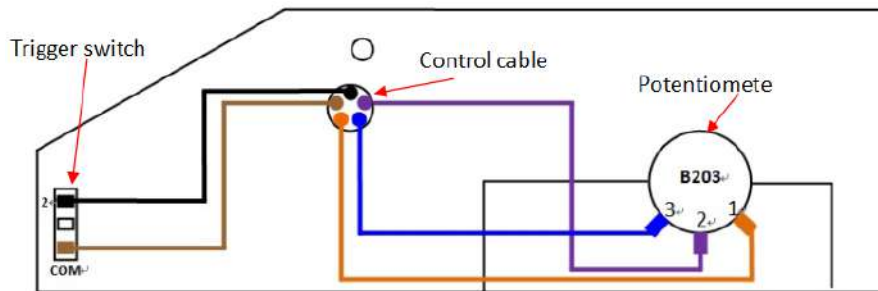

Remote Control Socket



Socket Pin	Function
1	Be shorted with 2
2	Be shorted with 1
3	20k ohm (maximum) connection to 20k ohm remote control potentiometer
4	Wiper arm connection to 20k ohm remote control potentiometer
5	Zero ohm (minimum) connection to 20k ohm remote control potentiometer
6	Not connected
7	Not connected
8	Trigger Switch Input
9	Trigger Switch Input
10	Not connected
11	Not connected
12	Not connected

§3.5 Operation Environment

- Height above sea level is below 1000m.
- Operation temperature range: -10°C ~ 40°C.
- Relative humidity is below 90% (20°C).
- Preferably site the machine some angles above the floor level, the maximum angle does not exceed 15°.
- Protect the machine against heavy rain or in hot circumstance against direct sunshine.
- The content of dust, acid, corrosive gas in the surrounding air or substance cannot exceed normal standard.
- Take care that there is sufficient ventilation during welding. There is at least 30cm free distance between the machine and wall.

§3.6 Operation Notices

- Read §1 carefully before attempting to use this equipment.
- Connect the ground wire with the machine.
- In case closing the power switch, no-load voltage may be exported. Do not touch the output electrode with any part of your body.
- Before operation, no concerned people should be left. Do not watch the arc in unprotected eyes.
- Ensure good ventilation of the machine to improve duty ratio.
- Turn off the engine when the operation finished to economize energy source.
- When power switch shuts off protectively because of failure. Don't restart it until problem is resolved. Otherwise, the range of problem will be extended.

§4 Maintenance & Troubleshooting

§4.1 Maintenance

In order to guarantee that arc welding machine works high-efficiently and in safety, it must be maintained regularly. Let customers understand the maintenance methods and means of arc welding machine more, enable customers to carry on simple examination and safeguarding by oneself, try one's best to reduce the fault rate and repair times of arc welding machine, so as to lengthen service life of arc welding machine .Maintenance items in detail are in the following table.

- **Warning: For safety while maintaining the machine, please shut off the supply power and wait for 5 minutes, until capacity voltage already drop to safe voltage 36V!**

date	Maintenance item
Daily examination	<p>Observe that whether panel knob and switch in the front and at the back of arc welding machine are flexible and put correctly in place. If the knob has not been put correctly in place, please correct. If you can't correct or fix the knob, please replace immediately.</p> <p>If the switch is not flexible or it can't be put correctly in place, please replace immediately. Please get in touch with maintenance service department if there are no accessories.</p> <p>After turn-on power, watch/listen to that whether the arc welding machine has shaking, whistle calling or peculiar smell. If there is one of the above problems, find out the reason to get rid of. If you can't find out the reason, please contact local this area agent or the branch company.</p> <p>Observe that whether the display value of LED is intact. If the display number is not intact, please replace the damaged LED. If it still doesn't work, please maintain or replace the display PCB.</p> <p>Observe that whether the min/max value on LED accords with the set value. If there is any difference and it has affected the normal welding craft, please adjust it.</p> <p>Check up that Whether fan is damaged and is normal to rotate or control. If the fan is damaged, please change immediately. If the fan does not rotate after the arc welding machine is overheated, observe that whether there is something blocked in the blade, if it is blocked, please get rid of. If the fan does not rotate after getting rid of the above problems, you can poke the blade by the rotation direction of fan. If the fan rotates normally, the start capacity should be replaced; If not, change the fan.</p> <p>Observe that whether the fast connector is loose or overheated. If the arc welding machine has the above problems, it should be fastened or changed.</p>

	Observe that whether the current output cable is damaged. If it is damaged, it should be wrapped up, insulated or changed.
Monthly examination	Use the dry compressed air to clear the inside of arc welding machine. Especially for clearing up the dusts on radiator, main voltage transformer, inductance, IGBT module, the fast recover diode and PCB, etc. Check up the bolt in arc welding machine, if it is loose, please screw down it. If it is skid, please replace. If it is rusty, please erase rust on bolt to ensure it works well.
Quarter-yearly examination	Whether the actual current accords with the displaying value. If they does not accord, they should be regulated. The actual current value can be measured by the adjusted plier-type ampere meter.
Yearly examination	Measure the insulating impedance among the main circuit, PCB and case, if it below 1MΩ, insulation is thought to be damaged and need to change, and need to change or strengthen insulation.

§4.2 Troubleshooting

- Before arc welding machines are dispatched from the factory, they have already been debugged accurately. So forbid anyone who is not authorized by us to do any change to the equipment!
- Maintenance course must be operated carefully. If any wire becomes flexible or is misplaced, it maybe potential danger to user!
- Only professional maintenance personal who is authorized by us could overhaul the machine!
- Guarantee to shut off the arc welding machine's power before turn on the outline of the equipment!
- If there is any problem and has no the authorized professional maintenance personal, please contact local agent or the branch company!

If there are some simple troubles of TIG DC PULSE-series welding machine, you can consult the following overhauling chart:

S/N	Troubles	Reasons	Solution
1	Turn on the power source, and the power lamp is on, but fan doesn't work	There is something in the fan	Clear out
		The start capacitor of fan damaged	Change capacitor
		The fan motor damaged	Change fan
2	The number on the display is not intact.	The LED in the display is broken	Change the LED

MAINTENANCE & TROUBLESHOOTING

S/N	Troubles		Reasons	Solution
3	The max and min value displayed doesn't accord with the set value.		The max value is not accordant	Adjust potentiometer I _{max} on the control board.
			The min value is not accordant	Adjust potentiometer in the current meter.
4	No no-load voltage output (MMA)		The machine is damaged	Check the main circuit and the Pr4.
5	Arc cannot be ignited (TIG)	There is spark on the HF igniting board.	The welding cable is not connected with the two output of the welder.	Connect the welding cable to the welder's output.
			The welding cable damaged.	Repair or change it.
			The earth cable connected unstably.	Check the earth cable.
			The welding cable is too long.	Use an appropriate welding cable.
			There is oil or dust on the workpiece.	Check and remove it.
			The distance between tungsten electrode and workpiece is too long.	Reduce the distance (about 3mm).
	There is not spark on the HF igniting board.	The HF igniting board does not work.	Repair or change Pr8	
		The distance between the discharger is too short.	Adjust this distance (about 0.7mm).	
6	No gas flow (TIG)		Gas cylinder is close or gas pressure is low	Open or change the gas cylinder
			Something in the valve	Remove it
			Electromagnetic valve is damaged	Change it
7	Gas always flows		The gas-test on the front panel is on	The gas-test on the front panel is off
			Something in the valve	Remove it
			Electromagnetic valve is damaged	Change it
			The adjustment knob of pre-gas time on the front panel is damaged	Repair or change it
8	The welding current cannot be adjusted		The welding current potentiometer on the front panel connection is not good or damaged	Repair or change the potentiometer
9	The welding current displayed isn't accordant with the actual value.		The min value displayed isn't accordant with the actual value.	Adjust potentiometer in on the power board.
			The max value displayed isn't accordant with the actual value.	Adjust potentiometer I _{max} on the power board.

MAINTENANCE & TROUBLESHOOTING

S/N	Troubles	Reasons		Solution
10	The penetration of molten pool is not enough.	The welding current is adjusted too low		Increase the welding current
11	The alarm lamp on the front panel is on	Over protection heat	Too much welding current	Reduce the welding current output
			Working time too long	Reduce the duty cycle (work intermittently)

§4.3 Electrical principle drawing

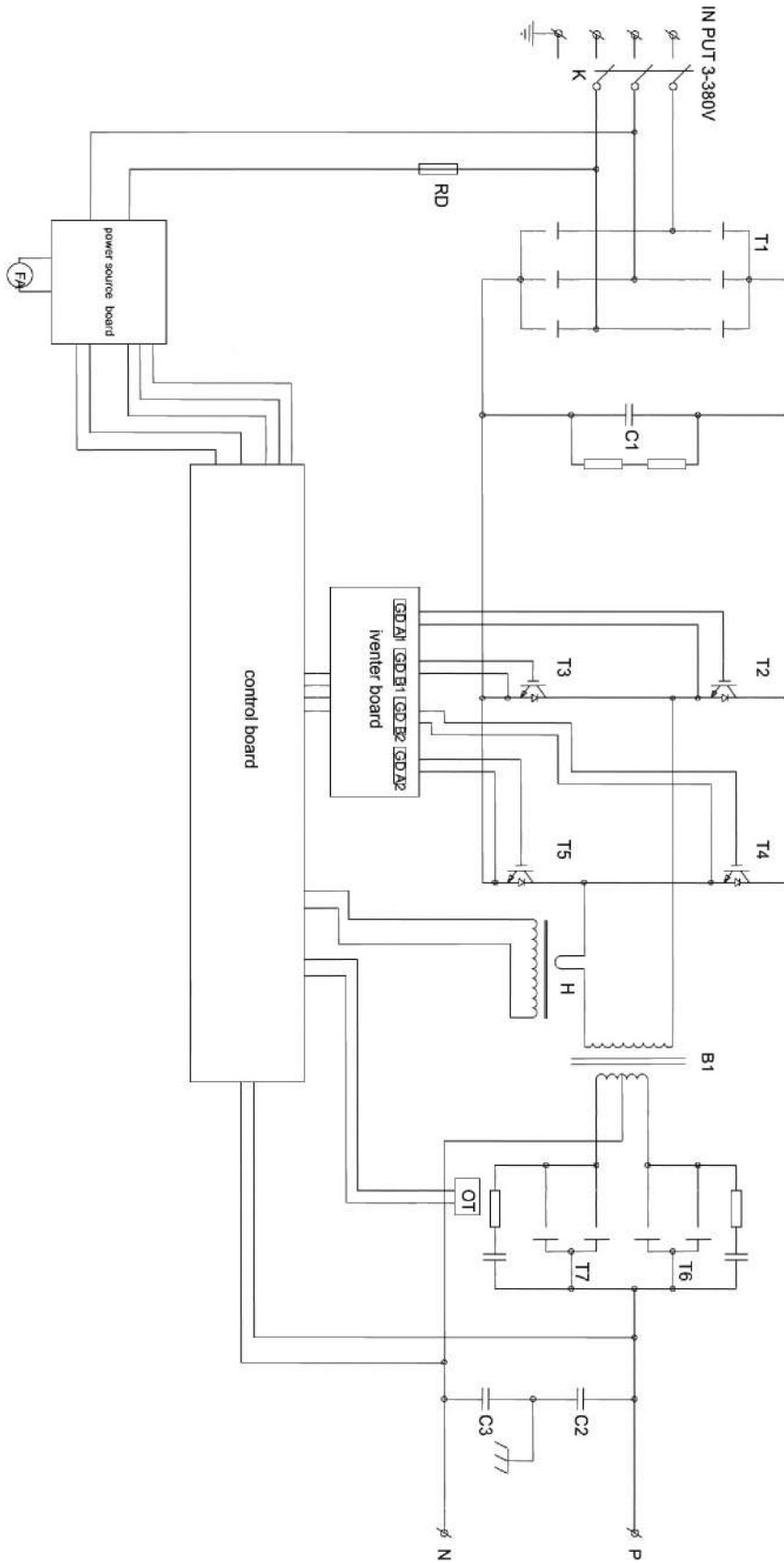

Power TIG Series



GeKaMac[®]



Gedik Welding Inc.

Ankara Caddesi No: 306 Şeyhli 34906 Pendik - İstanbul / Turkey

P. +90 216 378 50 00 • **F.** +90 216 378 20 44

www.gedikwelding.com